

* Take off JP1 jumper of all the distributors except in the last one.

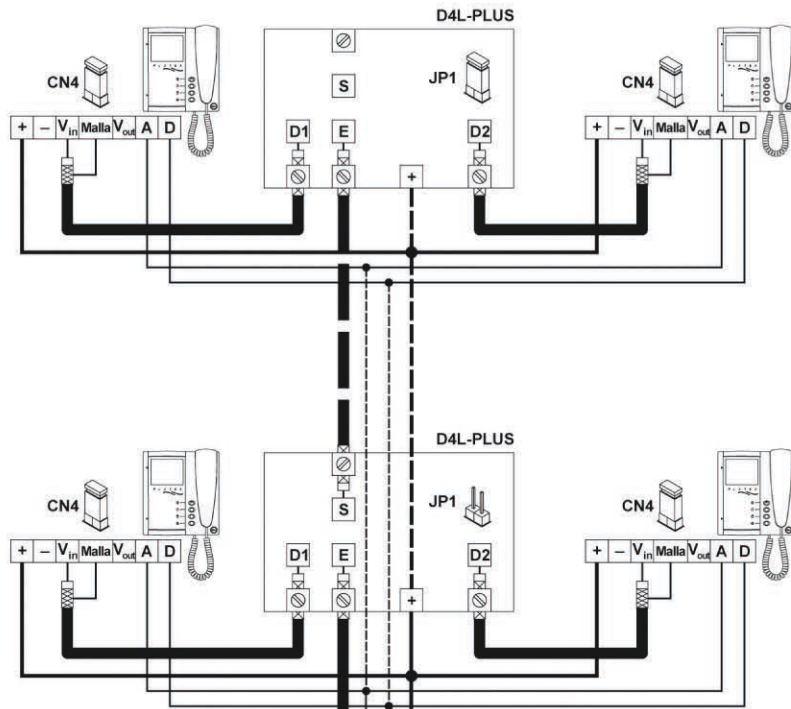

* Place this power supply as close as possible to the first distributor.

FA-Plus/C or FA-Plus

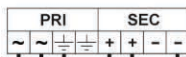

Master door panel

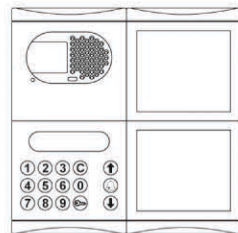

Optional

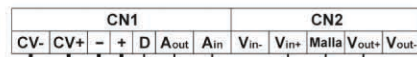
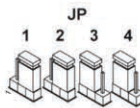

Slave door panel

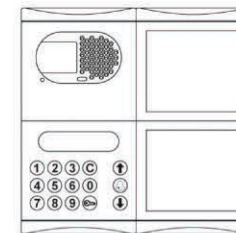

Optional

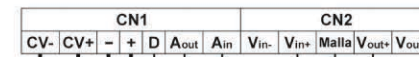
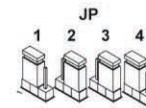

Video installation with coaxial cable.

The installation diagram shows the connection of a video system with one or several door panels for the same building.
 If the system has one door panel only, override the wiring to the second door panel.
 If the system has more than one door panel, wire the second panel as shown on the diagram. In case of more than two door panels, wire them as the second is connected.

SECTIONS CHART	Distance	
	50m.	150m.
+, -, CV+, CV-	1,00mm ²	2,50mm ²
A _{in} , A _{out} , A, D	0,25mm ²	0,25mm ²
V _{in+} , V _{out+} , V _{in-} , V _{out-}	RG-59	RG-59